



Optical Diagnostics

Thomas Tsang



- tight environment
- high radiation area
- non-serviceable area
- passive components
- optics only, no active electronics
- back illuminated with a single fiber laser - pulsed laser
- transmit image through flexible fiber bundle



Optical Diagnostics

Thomas Tsang

BROOKHAVEN
NATIONAL LABORATORY

Instrumentation Division Ultrafast Laser Laboratory

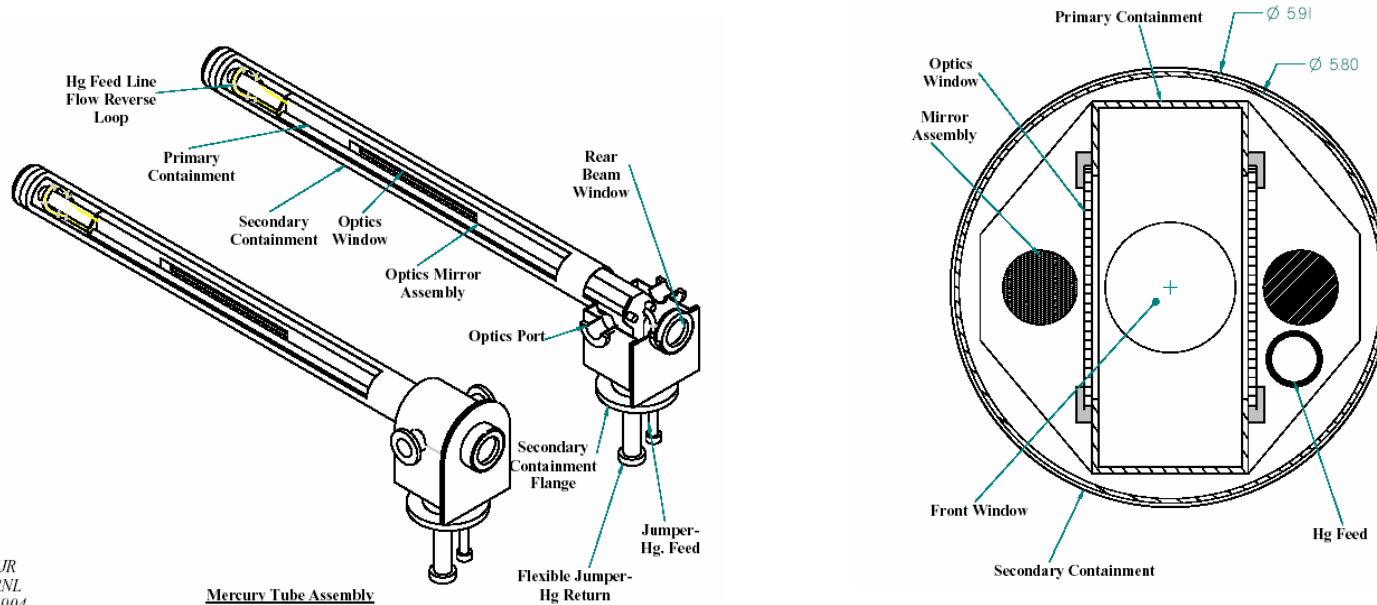

MJR
ORNL
081904

Mercury Tube Assembly

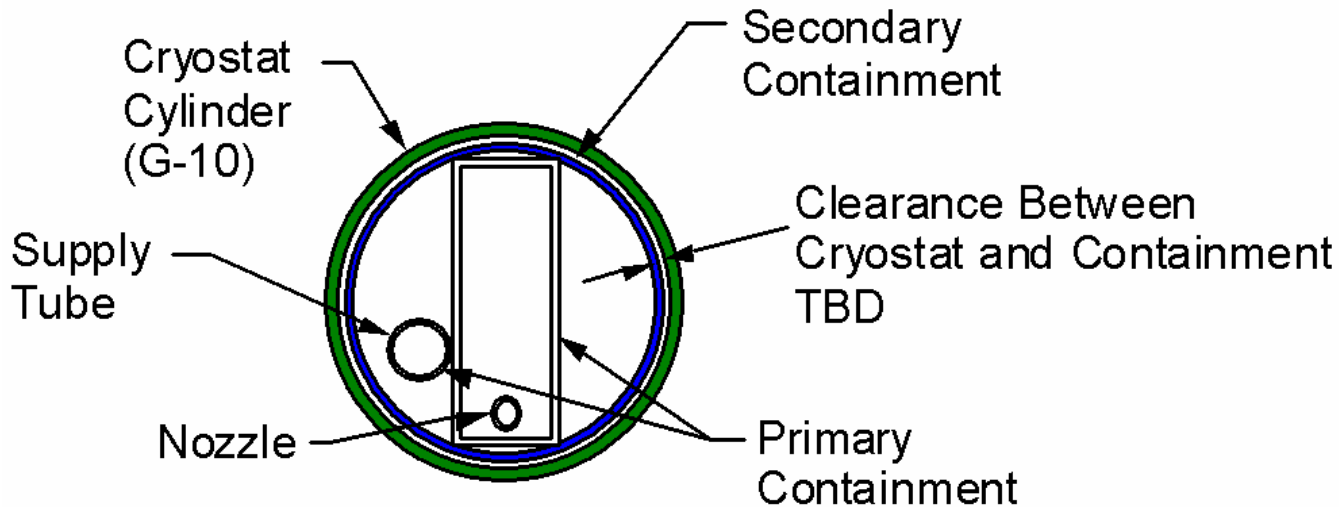



Optical Diagnostics

Thomas Tsang

BROOKHAVEN
NATIONAL LABORATORY

Instrumentation Division Ultrafast Laser Laboratory

Lumitex® Inc.

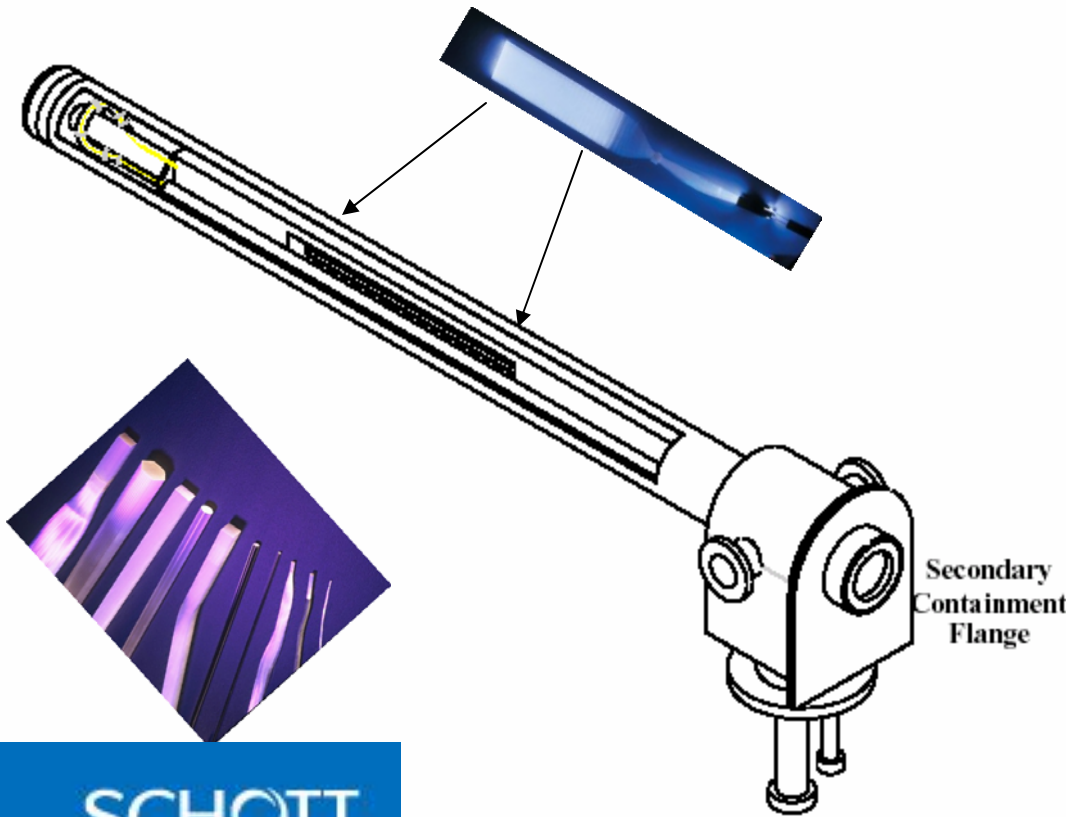

Typical fiber optic panel construction

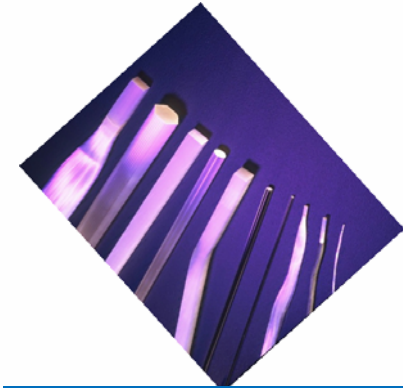
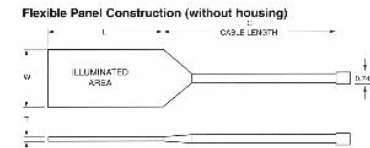
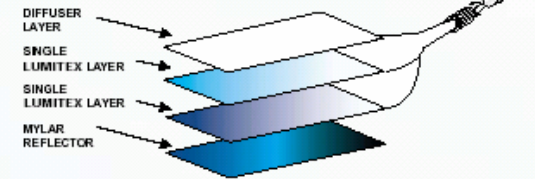

SCHOTT
glass made of ideas

Type	Part #	W	L	C	T	Active Area	Qty 1	Qty 2-4	Qty 5-9	Qty 10+
Rugged	004081	3.00	4.50	.36	.500	2 x 2	\$375	\$358	\$327	\$314
Rugged	004083	5.00	7.00	.36	.500	4 x 4	\$456	\$430	\$398	\$349
Rugged	004084	5.00	9.00	.36	.500	4 x 6	\$498	\$480	\$443	\$401
Flexible	003102	2.00	2.00	.36	.225	2 x 2	\$225	\$209	\$164	\$132
Flexible	003103	3.00	3.00	.36	.225	3 x 3	\$262	\$246	\$184	\$149
Flexible	003104	4.00	4.00	.36	.225	4 x 4	\$299	\$275	\$219	\$181
Flexible	003105	4.00	6.00	.36	.225	4 x 6	\$334	\$319	\$235	\$195
Flexible	003106	7.00	8.00	.36	.170	7 x 8	\$412	\$389	\$288	\$239

Notes: All Dimensions in inches, Prices subject to change without notice.



Optical Diagnostics

Thomas Tsang





Optical Diagnostics

Thomas Tsang

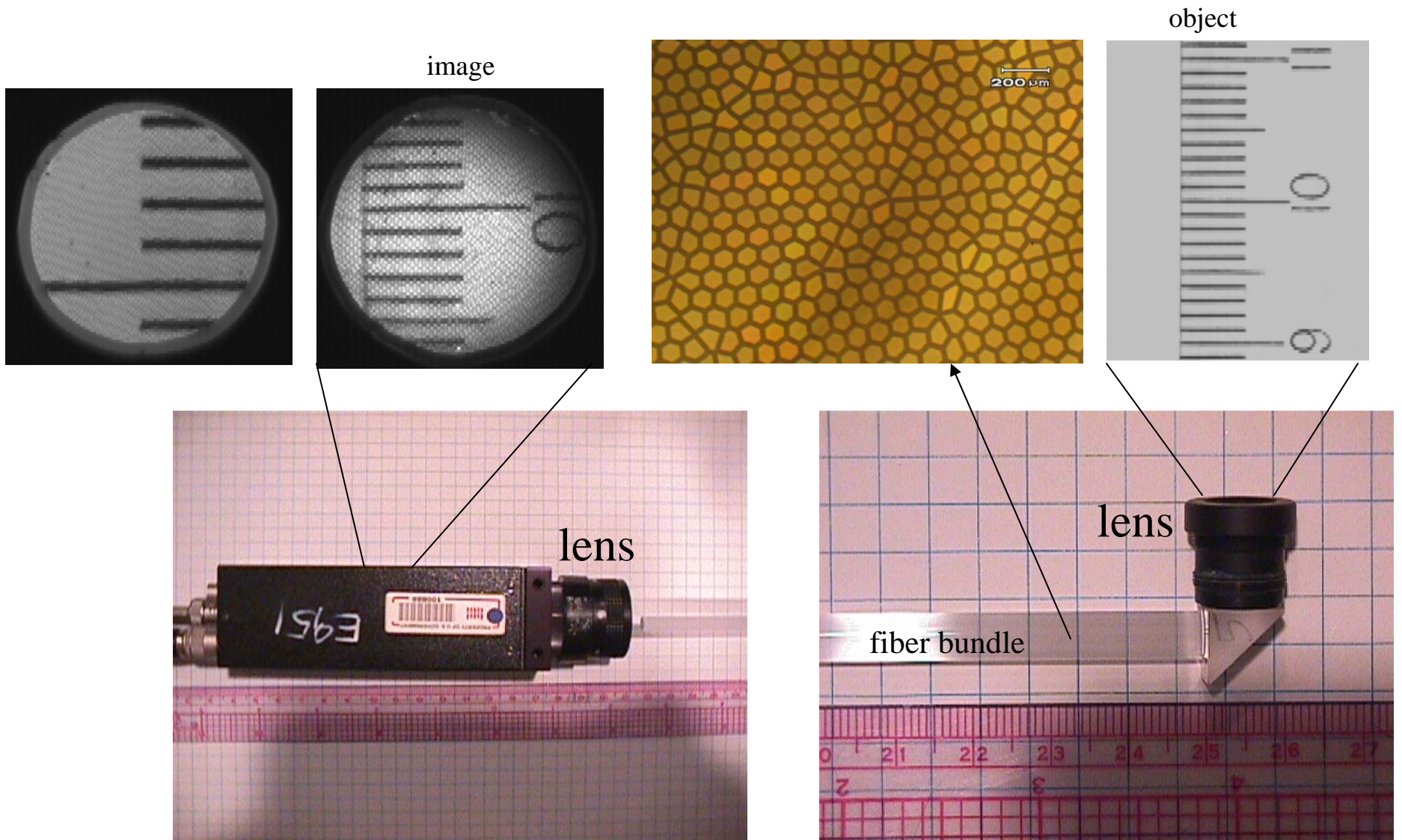



E951 – Hg jet results

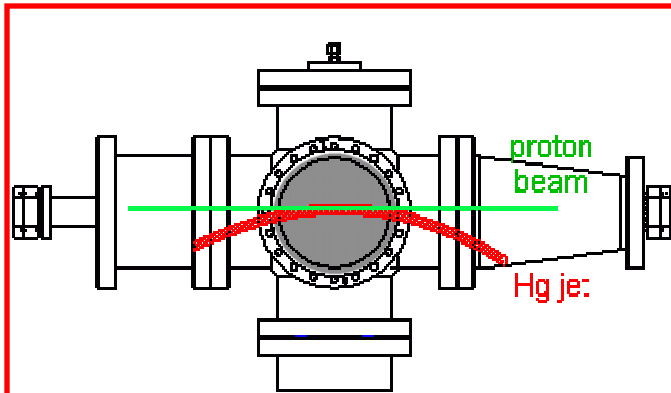

Hg jet target
The diameter of the mercury jet is ~ 1 cm traveling to the right in a speed of ~ 2.5 m/s with an interaction length of ~ 12 cm. The light illumination is in a diameter of ~ 10 cm.

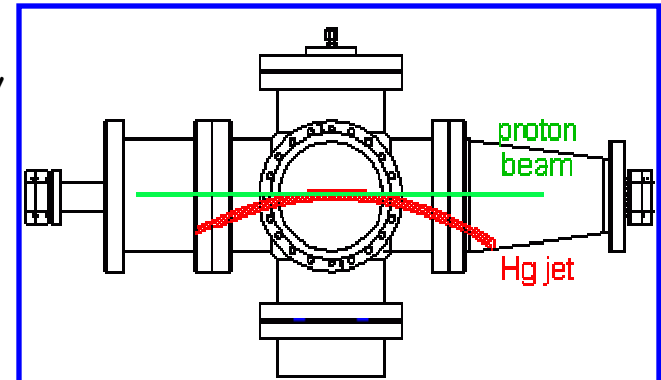

File: jet_042501_5_00000.eps 33, 229mm

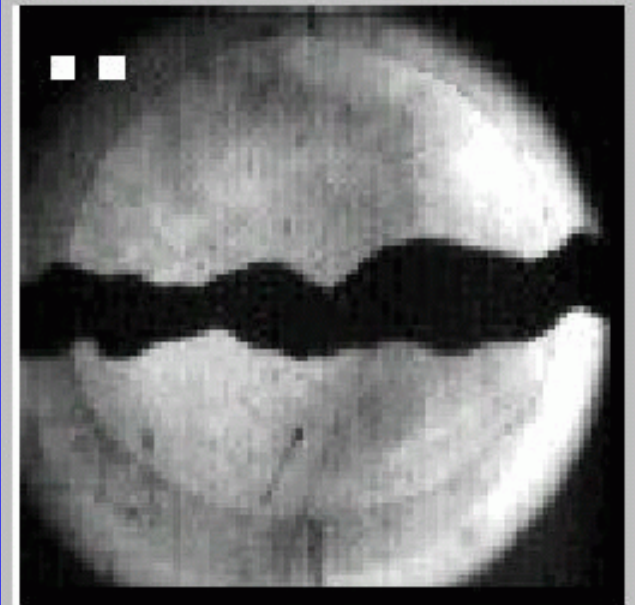

BNL data @ 3.8 TP
16 frames, at 1 ms/frame,
0.15 μ s exposure time
pulsed by a NIR laser
8 W peak power

field of view ~ 10 cm diameter

CERN data
0, 0.75, 2, 7, and 18 ms
frames. The electronic
shutter speed is 25 μ s
Illuminated by a 3 mW
CW red laser

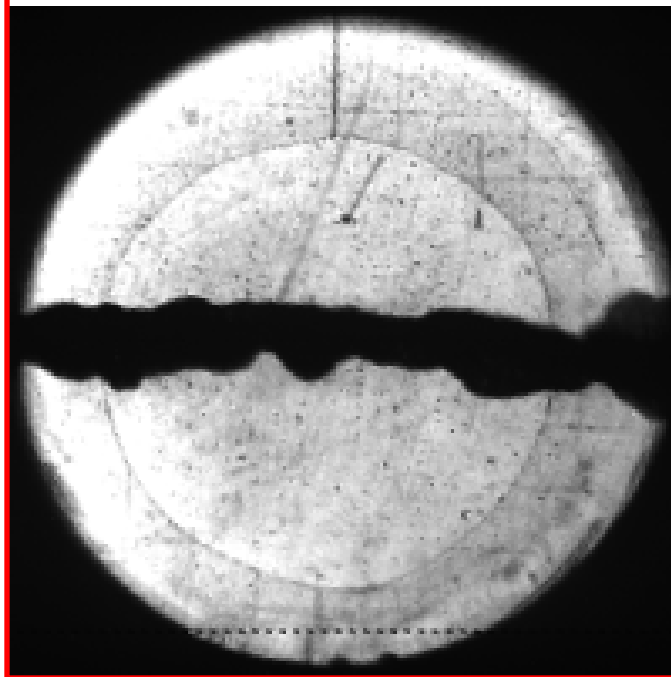

The maximum dispersal velocity of the mercury drops is ~ 10 m/s



E951 – more Hg jet results

E951 Mercury jet run 4-27-2001

file name: jet-4-27-01-13-movie.gif
grid size: 1 cm
field of view: 4.2 cm x 4.2 cm
frame rate: 100 microsecond
exposure time: 150 ns
proton energy: 24 GeV
of particles: 3.7 TP

100 μ s

E951 Mercury jet run 4-27-2001

file name: jet-4-27-01-20-movie.gif
grid size: 1 cm
field of view: 4.2 cm x 4.2 cm
frame rate: 10 microsecond
exposure time: 150 ns
proton energy: 24 GeV
of particles: 3.7 TP

10 μ s

E951 Mercury jet run 4-27-2001

file name: jet-4-27-01-28-movie.gif
grid size: 1 cm
field of view: 4.2 cm x 4.2 cm
frame rate: 1 microsecond
exposure time: 150 ns
proton energy: 24 GeV
of particles: 3.3 TP

1 μ s

- No evident of back propagating to the nozzle
- Hg break up \sim 40 us after proton impact



E951 – more Hg jet results

E951 Mercury jet run 4-27-2001

file name: jet-4-27-01-14-movie.gif
grid size: 1 cm
field of view: 4.2 cm x 4.2 cm
frame rate: 100 microsecond
exposure time: 150 ns
proton energy: 24 GeV
of particles: 1.0 TP

1 TP

E951 Mercury jet run 4-27-2001

file name: jet-4-27-01-12-movie.gif
grid size: 1 cm
field of view: 4.2 cm x 4.2 cm
frame rate: 100 microsecond
exposure time: 150 ns
proton energy: 24 GeV
of particles: 2.6 TP

2.6 TP

E951 Mercury jet run 4-27-2001

file name: jet-4-27-01-13-movie.gif
grid size: 1 cm
field of view: 4.2 cm x 4.2 cm
frame rate: 100 microsecond
exposure time: 150 ns
proton energy: 24 GeV
of particles: 3.7 TP

3.7 TP

- Hg droplets velocities increase roughly with proton beam energy